



Electrolux
PROFESSIONAL

Premium Preparation 1800 mm Work Table

ITEM # _____

MODEL # _____

NAME # _____

SIS # _____

AIA # _____

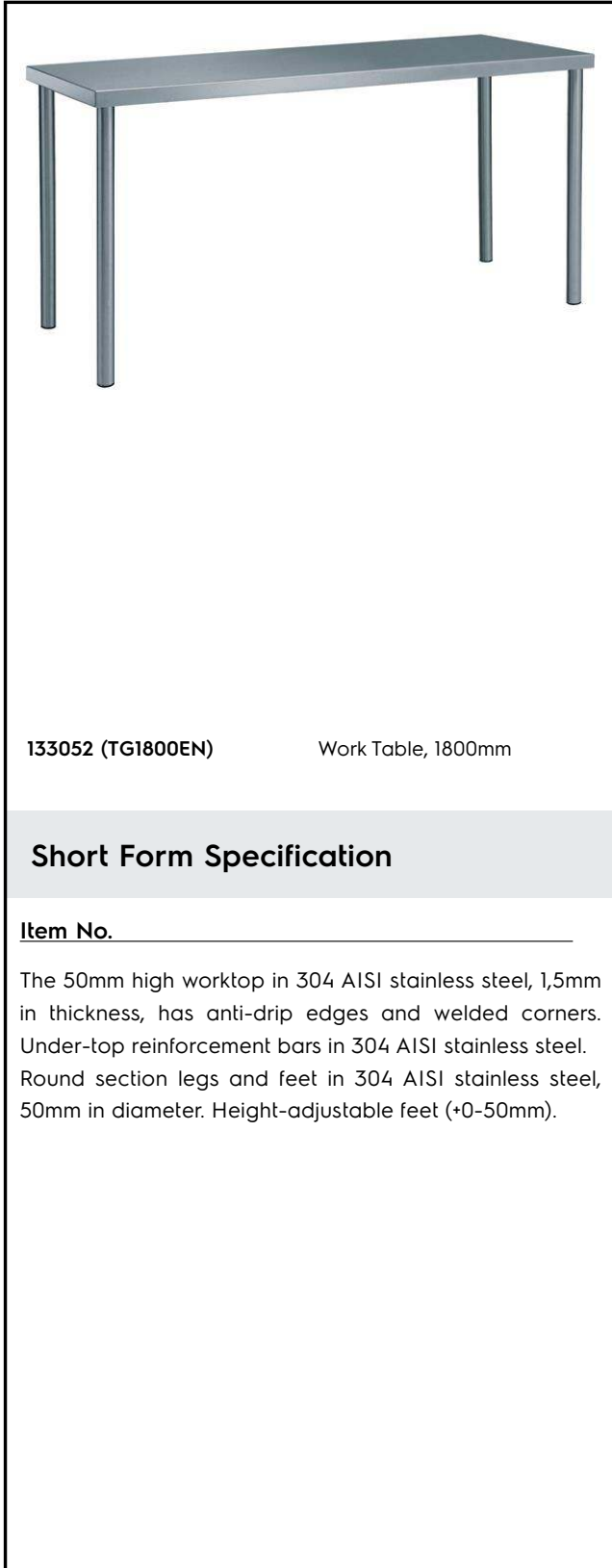

133052 (TG1800EN)

Work Table, 1800mm

Short Form Specification

Item No. _____

The 50mm high worktop in 304 AISI stainless steel, 1,5mm in thickness, has anti-drip edges and welded corners. Under-top reinforcement bars in 304 AISI stainless steel. Round section legs and feet in 304 AISI stainless steel, 50mm in diameter. Height-adjustable feet (+0-50mm).

Main Features

- The table can be ordered with the drawer of 400 mm or 600 mm (optional accessory): thanks to the design of the drawer, additional drawers can be added to the first single drawer to create chest of 2, 3 or 4 drawers based on customer's needs.
- Sturdiness, stability and reliability of table accurately tested.

Construction

- Worktop with 50 mm high profile, in s/s Scotch Brite finishing, 15/10 in thickness with anti-drip edges and welded corners.
- Round section legs with feet in 304 AISI stainless steel, 50 mm in diameter, adjustable in height by +0/-40 mm.
- Delivered in knock-down package.
- Wide range of taps are available to suit every need.
- 100 mm upstand with 10 mm radiused corner and 13 mm deep, designed to be used against a wall.
- Heavy duty construction entirely in AISI 304 stainless steel to offer maximum durability.

Optional Accessories

- Single drawer GN 1/1, 400mm PNC 855280
- Single drawer, 600mm PNC 855281
- Lower shelf for 1800mm for PNC 855285
units
- Set of 4 wheels (2 with brake) PNC 855288
d. 100mm
- 3-sided underframe for PNC 855293
1800mm tables
- Additional drawer, 600mm (to PNC 855295
set up a chest of 2, 3, 4
drawers)
- Additional drawer GN 1/1, PNC 855298
400mm (to set up a chest of 2,
3, 4 drawers)

APPROVAL: _____

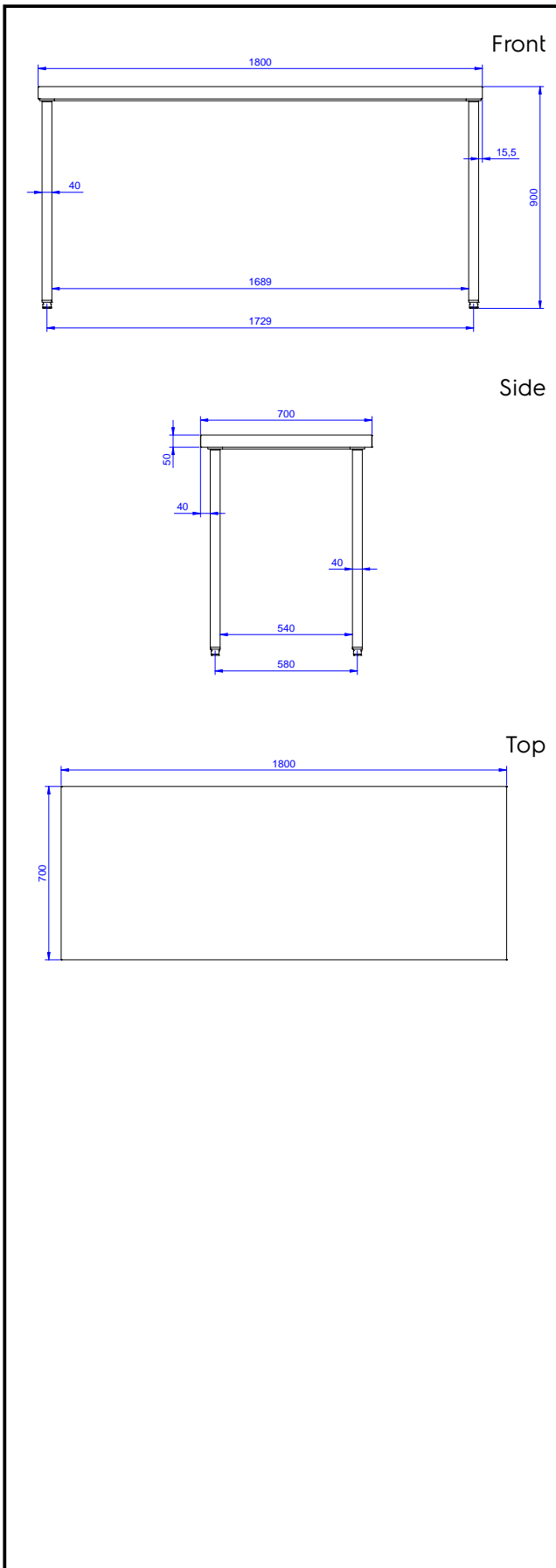

Experience the Excellence
www.electroluxprofessional.com

Key Information:

External dimensions, Width: 133052 (TG1800EN)	1800 mm
External dimensions, Depth:	700 mm
External dimensions, Height:	900 mm
Worktop thickness:	50 mm
Net weight:	54 kg
Drawer combinations - No. 400 mm drawers	3
Drawer combinations - No.600 mm drawers	2
Drawer combinations - No. 400 + 600 mm drawers	2+1